

A

B

C

D

E

F

4

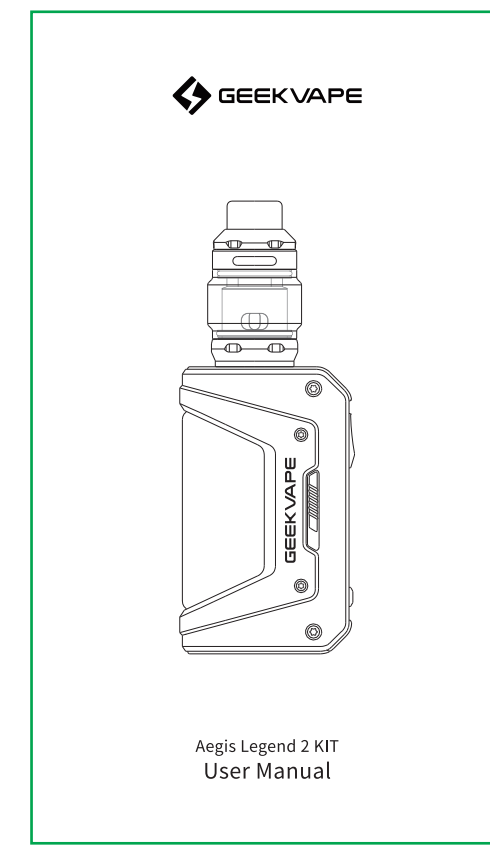

封面

意大利语

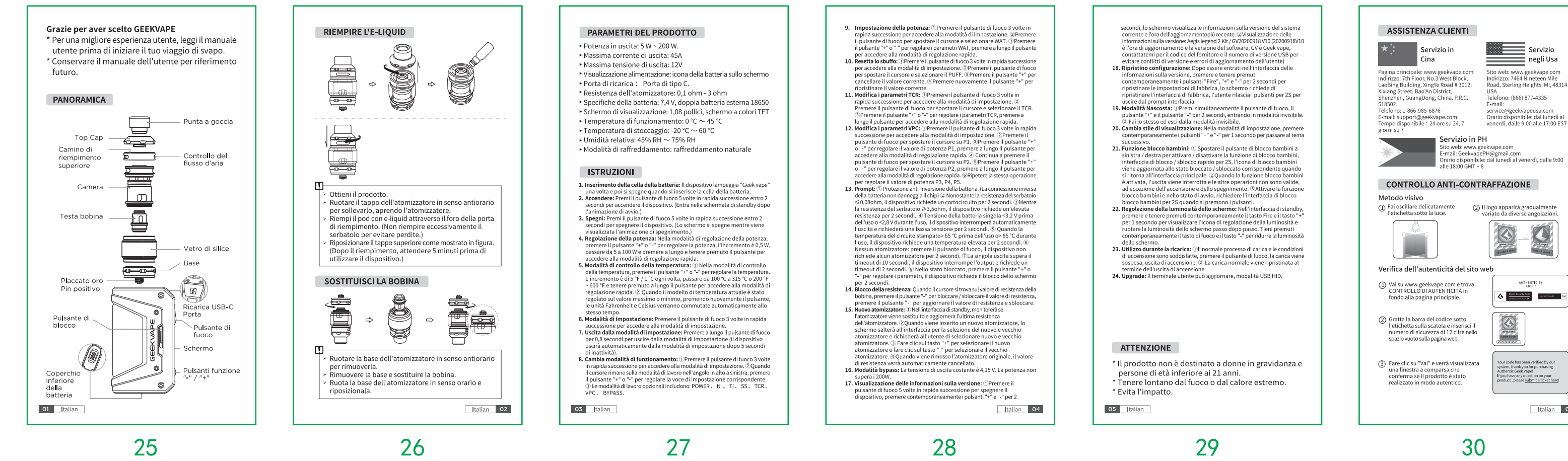

3

英语

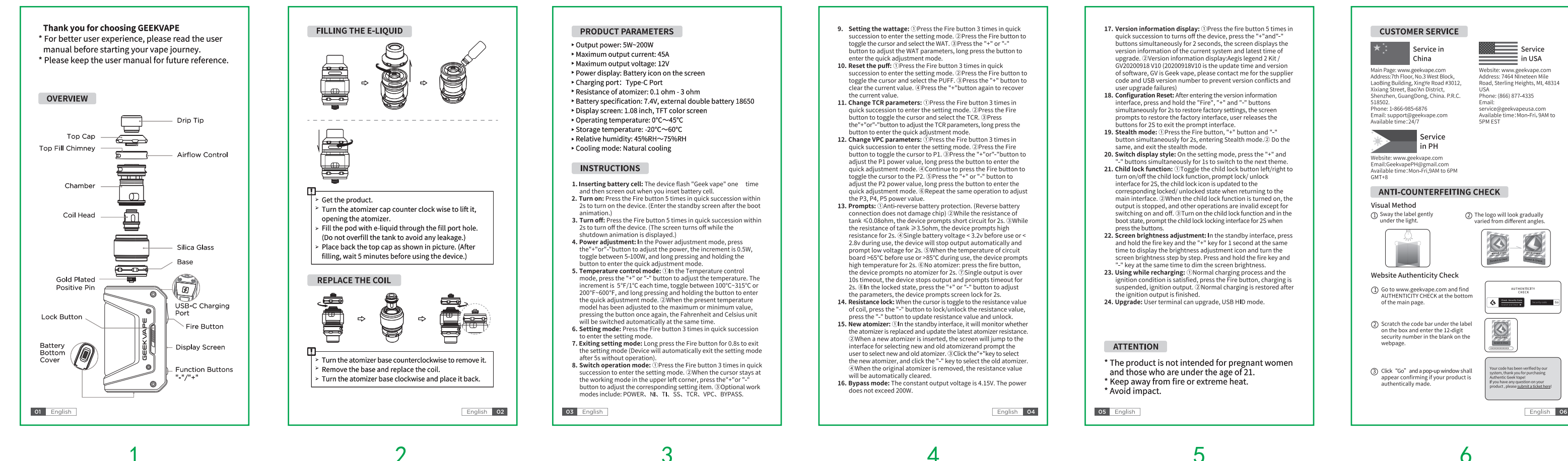

俄语

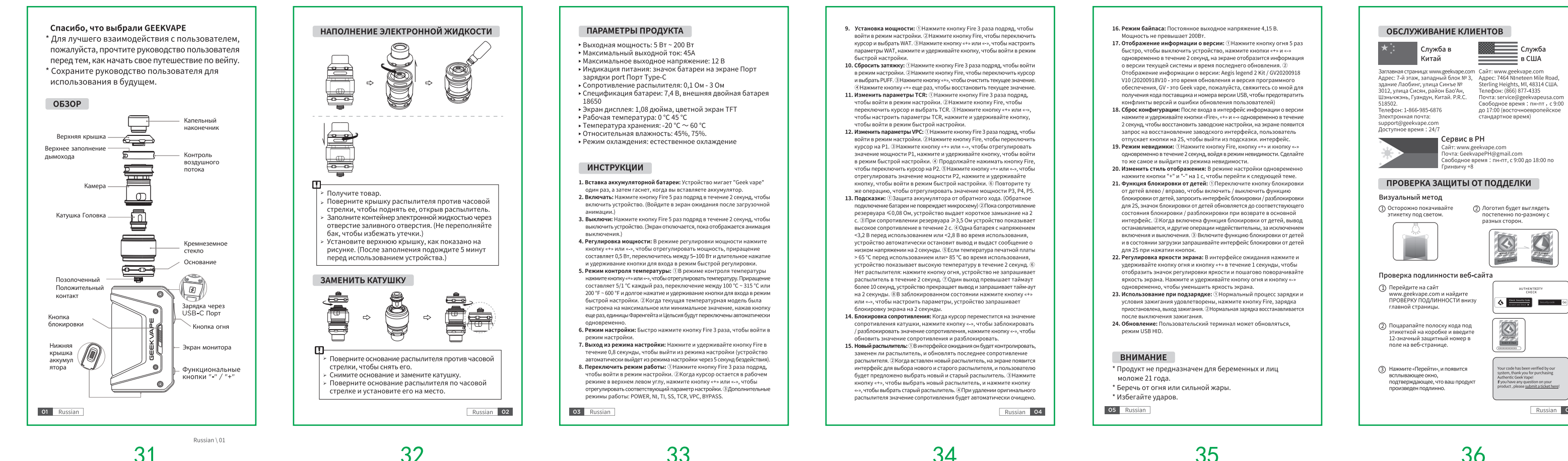

法语

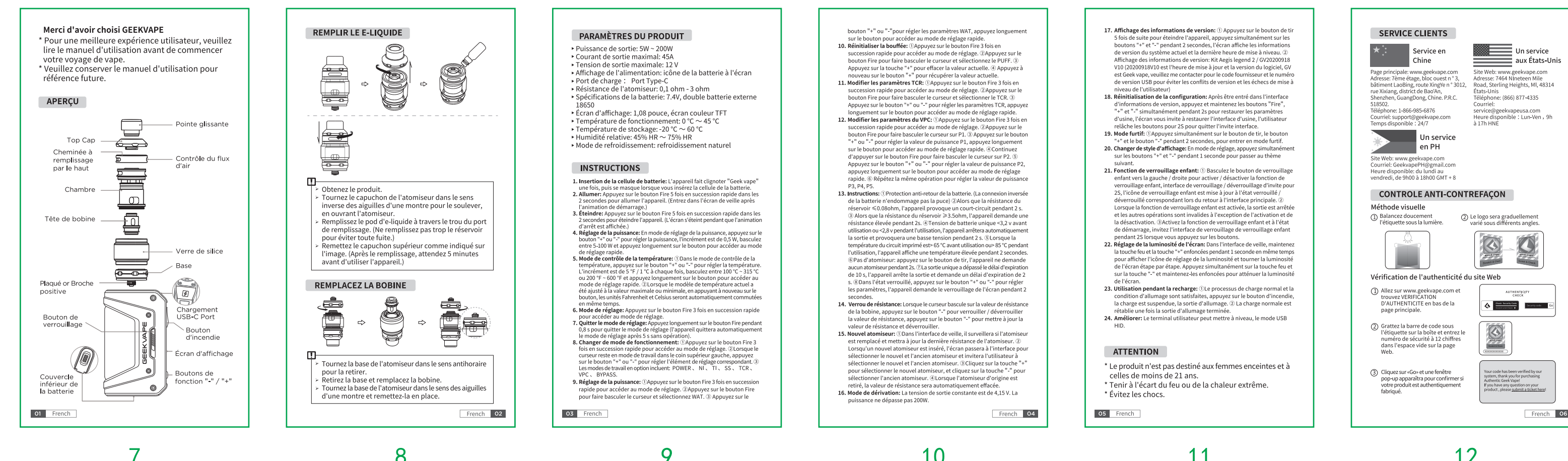

丹麦语

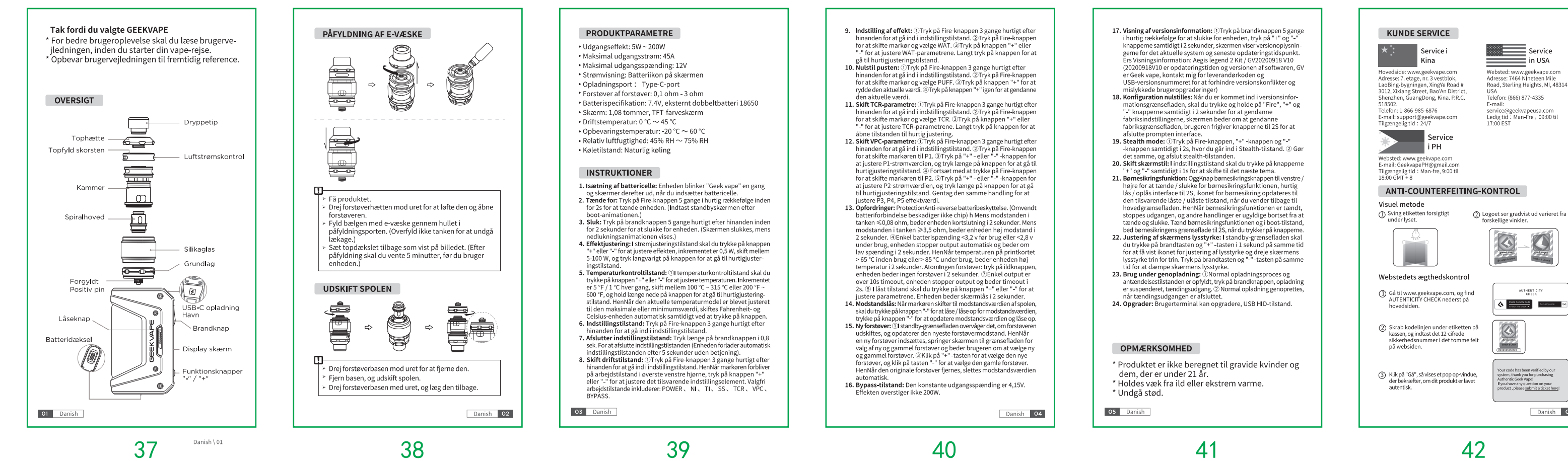

德语

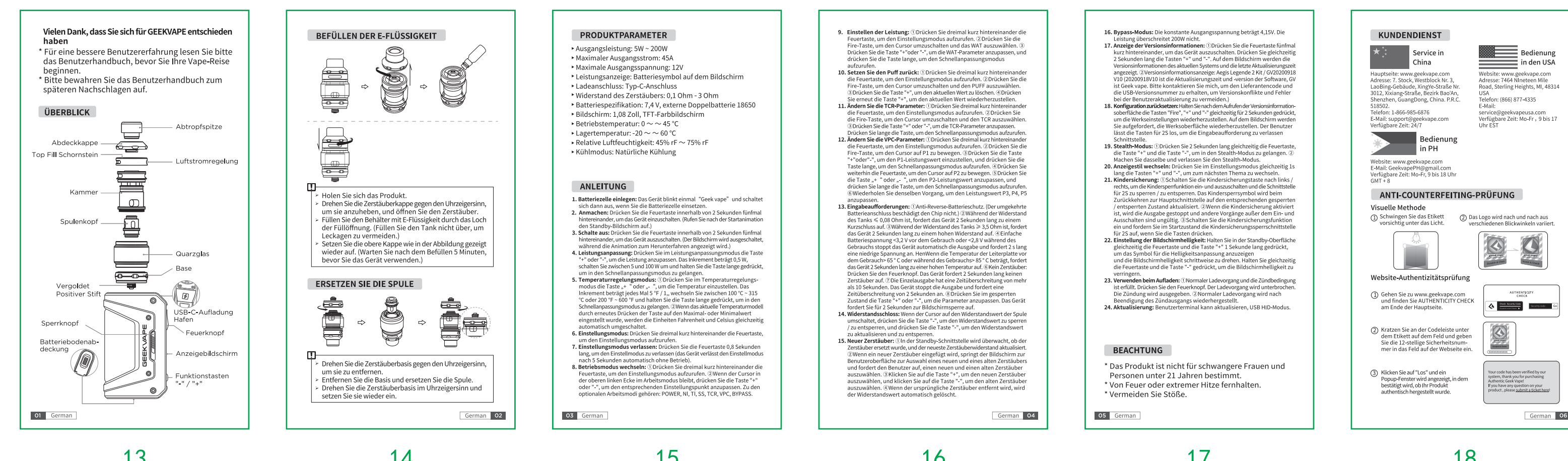

荷兰语

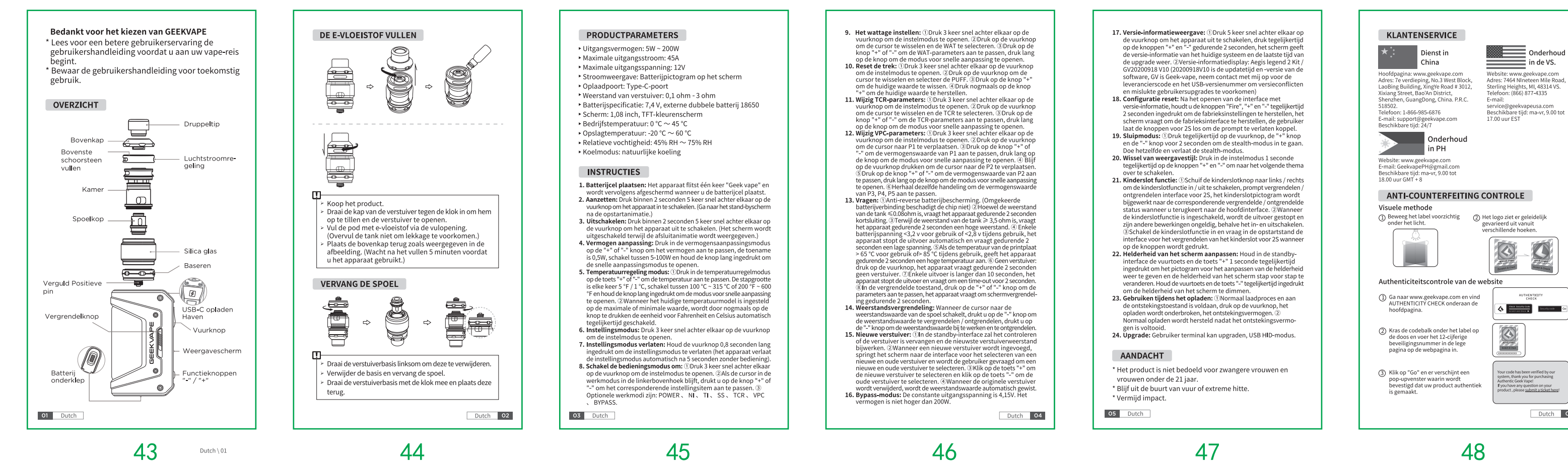

2

西班牙语

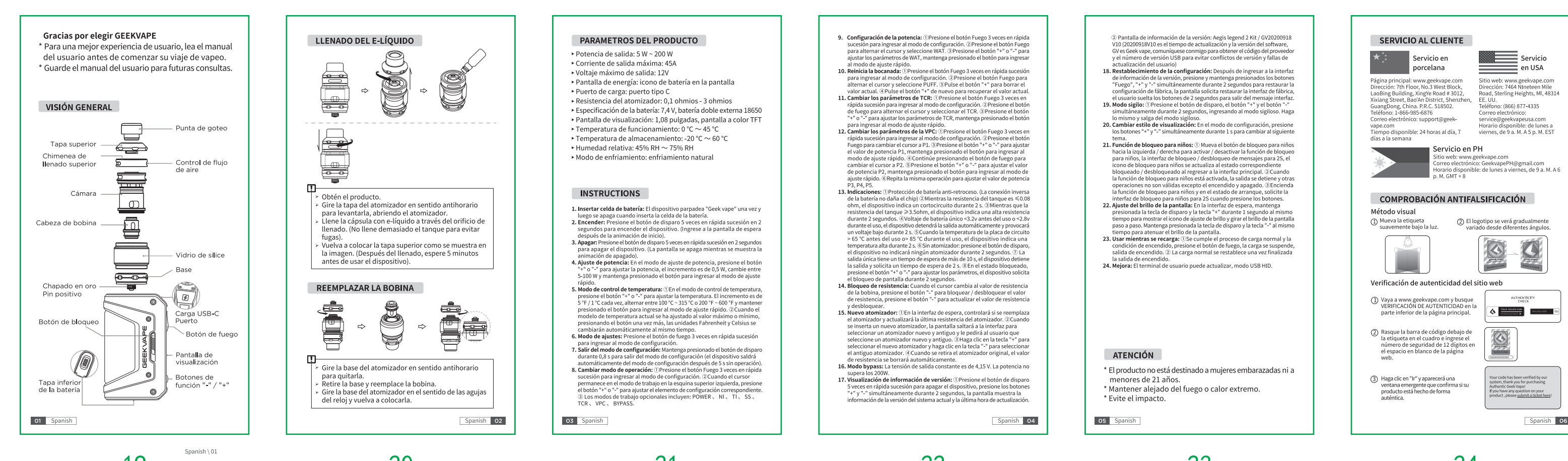

印尼语

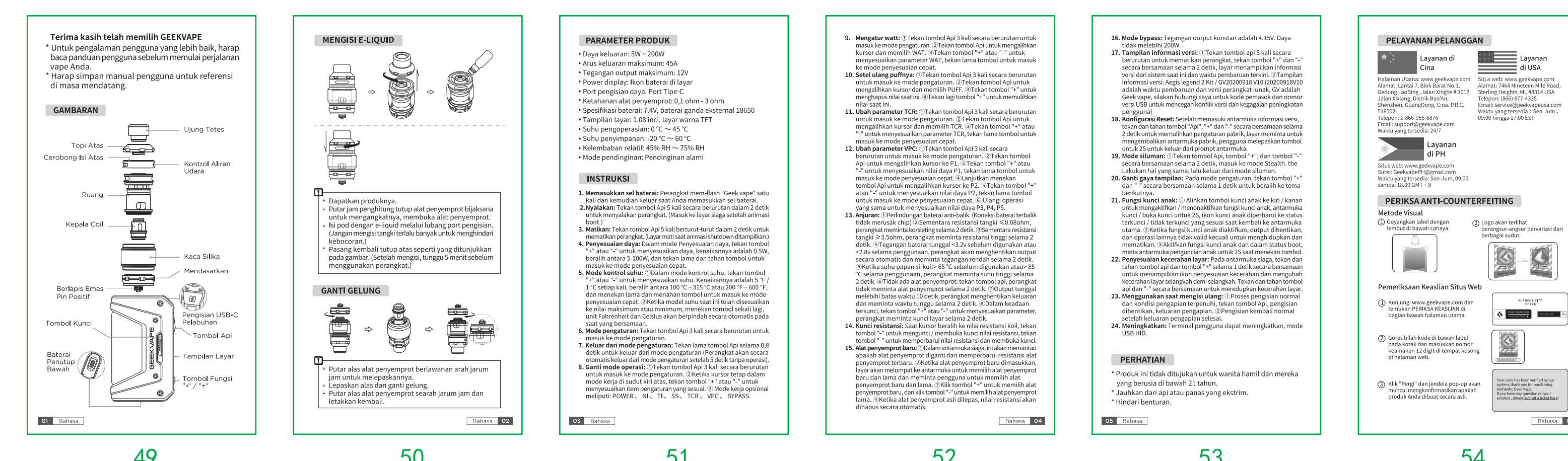

封底

要求:

- 1.材料: 80g书写纸
- 2.成品尺寸: 60*110mm≤0.5
- 3.工艺: 双面印刷 骑马订。
- 4.颜色: 印单黑, 色差ΔE≤1.00
- 5.油墨, 要符合欧盟为RoHS环保标准。
- 6.页码顺序依次按封面、1、2...53、54、封底
印刷以文件为准, 严格按图纸做货。裁切边缘须整齐无毛边。

 深圳市基克纳科技有限公司
Geekvape Technology co, LTD

绘图
PRODUCTNAME

魏鹏
2021/3/25

比例 1:1
SCALE

未标公差 OTHER TOLERANEC	产品名称 PRODUCTNAME	Aegis Legend 2 KIT - 说明书
	产品编码 PART NO	GS0028
	产品图号 PART NO	GS0028-P-11

审核
CHECKED

核准
APPROVED

UNIT(单位): mm
REV(版本): A1

